

M12 Female Right Angled 5PIN

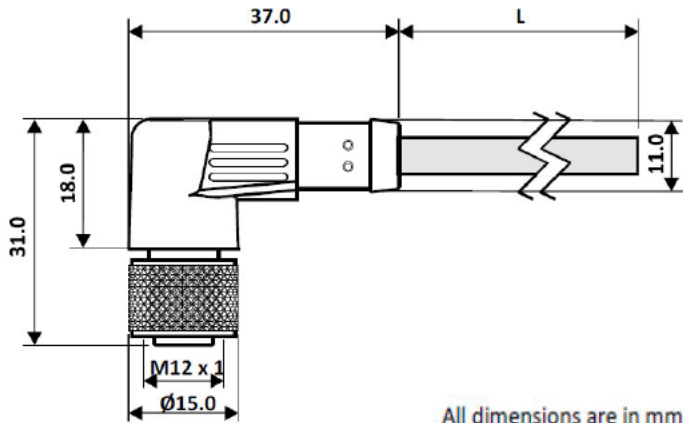

All dimensions are in mm.

Pin Assignment

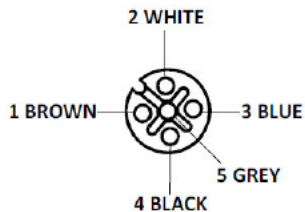

General Specification

Rated Operational Voltage	60 V
Current Rating	4A
Insulation Resistance	>= 100 MΩ
Temperature Range	-25°C ... +75°C
Degree of Protection	IP67

Material Specification

Grip Material	PU
Contact	Cu-Zn
Contact Plating	Gold Plated
Contact Carrier	Nylon 66
O-Ring	Neoprene
Grip Colour	Black
Coupling Nut	Brass Nickel-Plated

Cable Specification

Cable Length-L	2 m
Cable Type	5 Core PVC Multi Strand
Sheath Colour	Black
Cross Section of Wire	0.25 sq. mm
Core Dia	1.25 mm
Cable Dia	5.1 ± 0.1 mm
Termination	Partially Stripped

TOLERANCE				
SCALE	UNIT			
DRAW	Brown	DATE	23.10.2018	TITLE SM C10 BF12-R55N0-02
CHECK	Walter	REV		
		DESCRIPTION M12 Female Right Angled 5PIN		