

M12 Female Panel Mount

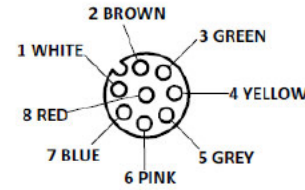

Pin Assignment



General Specification

Rated Operational Voltage	30 V
Current Rating	2A
Insulation Resistance	>= 100 MΩ
Temperature Range	-25°C ... +75°C
Degree of Protection	IP67

Material Specification

Housing Material	Brass Ni Plated
Contact	Cu-Zn
Contact Plating	Gold Plated
Contact Carrier	Nylon 66
O-Ring	Neoprene
Pole	8
Clamp Nut	PG9

Cable Specification

Cross Section of Wire	0.25 sq.mm
Termination	Partially Stripped
Cable length	200 mm

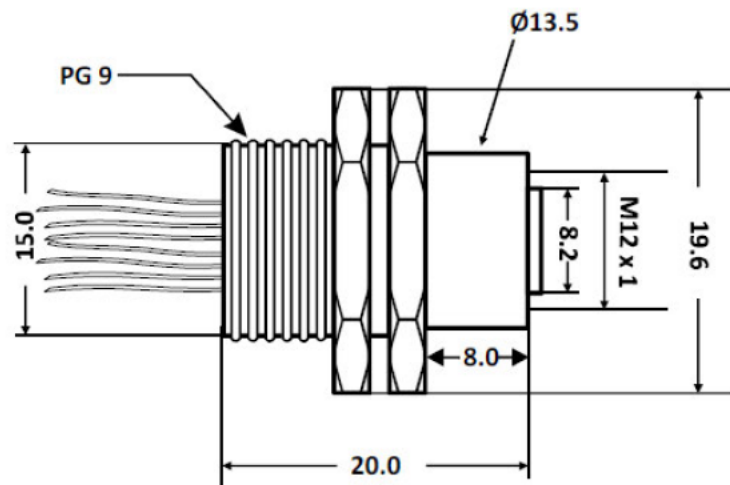

All dimensions are in mm.

TOLERANCE				
SCALE	UNIT			
DRAW	Brown	DATE	8.11.2018	TITLE SM C10 PF12-FPBR8-P2
CHECK	Walter	REV		
		DESCRIPTION M12 Female Panel Mount		